



DOTATA DI RINFORZI IN HB400 NEI PUNTI DI MAGGIOR USURA, TAGLIENTI LATERALI REALIZZATI IN FUSIONE E SOTTOLAMA REVERSIBILE IMBULLONATA LA RENDONO ADATTA PER LAVORAZIONI SU TERRENI PARTICOLARMENTE ABRASIVI.

**SU LARGHEZZE SUPERIORI A 1400 MM È FORTEMENTE RACCOMANDATA L'INSTALLAZIONE DI LUNETTE DI RINFORZO, AL FINE DI EVITARE DANNI ALLA BENNA IN CASO DI CARICHI DI LAVORO GRAVOSI O UTILIZZO SU TERRENI PARTICOLARMENTE DURI:**

- LARGHEZZE DA 1400 A 1500 MM: NR. 1 LUNETTA
- LARGHEZZE DA 1600 A 1600 MM: NR. 2 LUNETTE
- LARGHEZZE DA 1800 A 2200 MM: NR. 3 LUNETTE

MOD.	SPR35	SPR40	SPR40	SPR45	SPR50	SPR55	MIDI		EXCAVATOR
							SPR60	SPR65 HD	
TONS	1,8 - 2,5	2,0 - 2,5	2,5 - 4,0	4,0 - 5,0	5,0 - 7,5	7,5 - 10,0	10,0 - 12,0	12,0 - 18,0	18,0 - 22,0



ADAPTERS

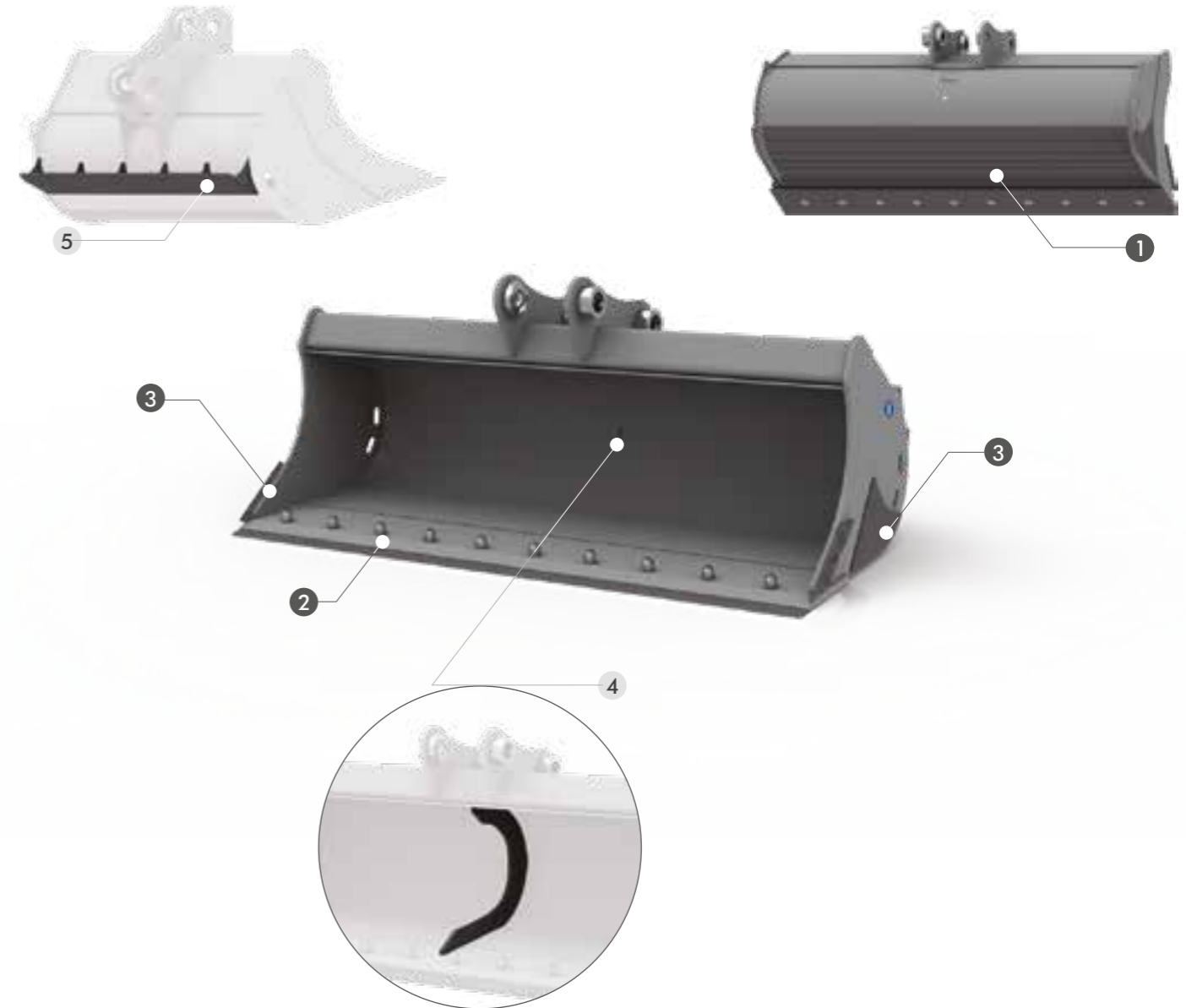

## SPECIFICHE TECNICHE STANDARD

- 1 FASCE DI RINFORZO HB400**  
LE FASCE DI RINFORZO ORIZZONTALI SALVAGUARDANO IL FONDO DALL'USURA AUMENTANDONE LA RESISTENZA.
- 2 SOTTOLAMA IMBULLONATA HB400**  
SOTTOLAMA IN HB400 IMBULLONATA REVERSIBILE CONSIGLIATA PER OPERARE SU TERRENI PARTICOLARMENTE ABRASIVI.
- 3 TAGLIENTI IN FUSIONE E RINFORZI LATERALI HB400**  
REALIZZATI IN FUSIONE HB400, POSIZIONATI NELLE SUPERFICI DI MAGGIOR ATTRITO CONFERISCONO UN'ELEVATA RESISTENZA ALL'USURA.

## OPTIONAL

- 4 LUNETTA**  
GARANTISCE UNA MAGGIORE RESISTENZA STRUTTURALE. **FORTEMENTE CONSIGLIATA NELLE BENNE CON LARGHEZZA UGUALE O SUPERIORE A 1400 MM.**
- 5 RASOIO POSTERIORE**  
MANTENENDO RACCOLTO IL BRACCIO DELLA MACCHINA PERMETTE DI RIFINIRE SUPERFICI IN MANIERA UNIFORME.

## SPR35 PESO MACCHINA 1,2 - 1,8

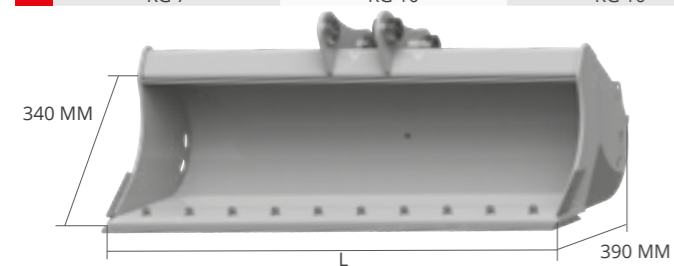
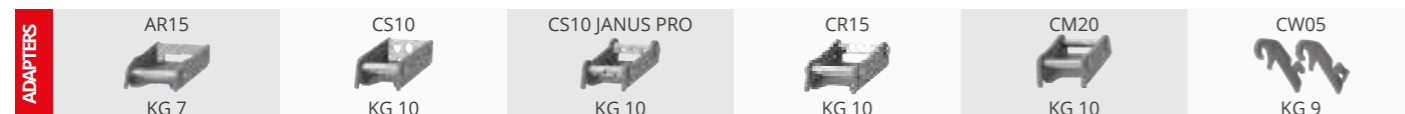

### OPTIONAL

5  
RASOIO POSTERIORE

L MM	PESO KG*	CAP. SAE L	ADAPTERS
800	63	75	AF - AR - CS
			CR - CM
			CW - CS JANUS PRO
1000	76	96	AF - AR - CS
			CR - CM
			CW - CS JANUS PRO
1200	90	117	AF - AR - CS
			CR - CM
			CW - CS JANUS PRO

## SPR40 PESO MACCHINA 2,0 - 2,5

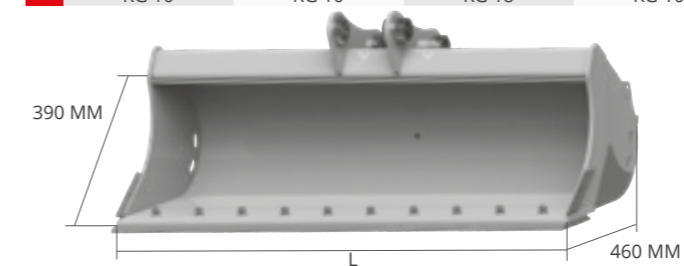
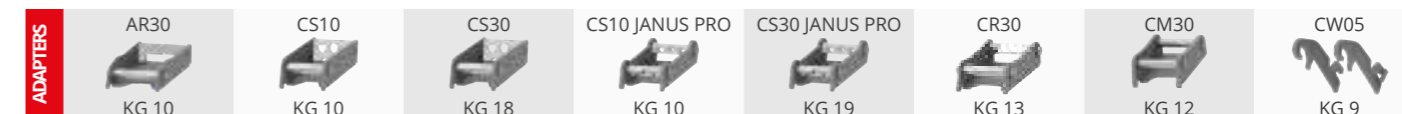

### OPTIONAL

4 LUNETTA 5 RASOIO POSTERIORE

L MM	PESO KG*	CAP. SAE L	ADAPTERS
1000	108	125	AF - AR - CS
			CR - CM
			CW - CS JANUS PRO
1200	128	154	AF - AR - CS
			CR - CM
			CW - CS JANUS PRO

## SPR40 PESO MACCHINA 2,5 - 4,0

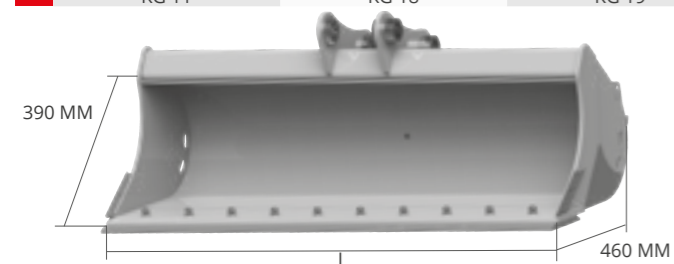
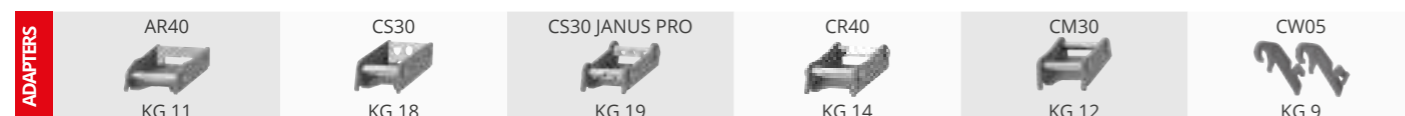

### OPTIONAL

4 LUNETTA 5 RASOIO POSTERIORE

L MM	PESO KG*	CAP. SAE L	ADAPTERS
1000	108	125	AF - AR - CS
			CR - CM
			CW - CS JANUS PRO
1200	128	154	AF - AR - CS
			CR - CM
			CW - CS JANUS PRO
1400	148	182	AF - AR - CS
			CR - CM
			CW - CS JANUS PRO

## SPR45 PESO MACCHINA 4,0 - 5,0

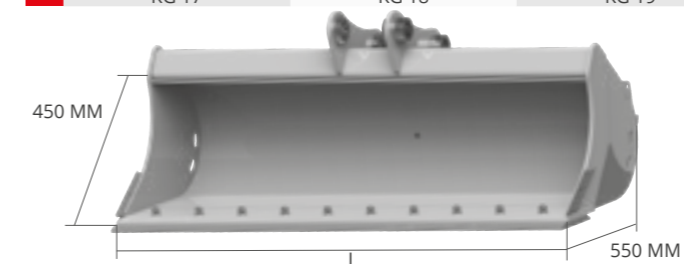
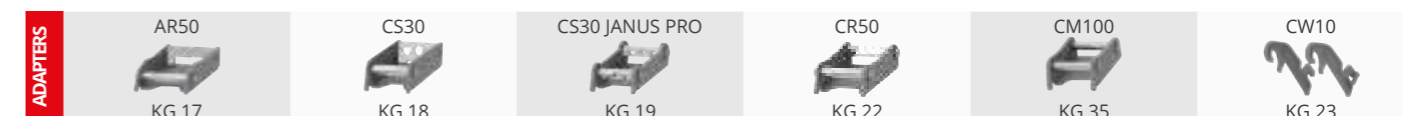

### OPTIONAL

4 LUNETTA 5 RASOIO POSTERIORE

L MM	PESO KG*	CAP. SAE L	ADAPTERS
1200	160	213	AF - AR - CS
			CR - CM
			CW - CS JANUS PRO
1400	185	254	AF - AR - CS
			CR - CM
			CW - CS JANUS PRO
1500	197	274	AF - AR - CS
			CR - CM
			CW - CS JANUS PRO

\* peso vasca escluso di attacchi e denti

\* peso vasca escluso di attacchi e denti

## SPR50 PESO MACCHINA 5,0 - 7,5

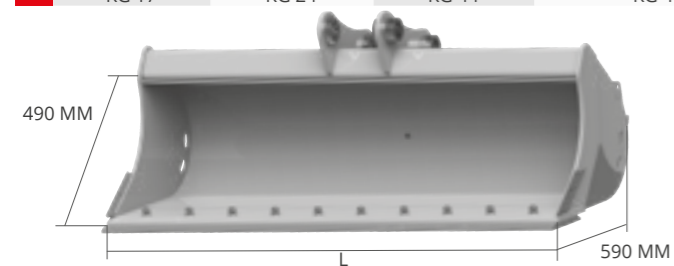
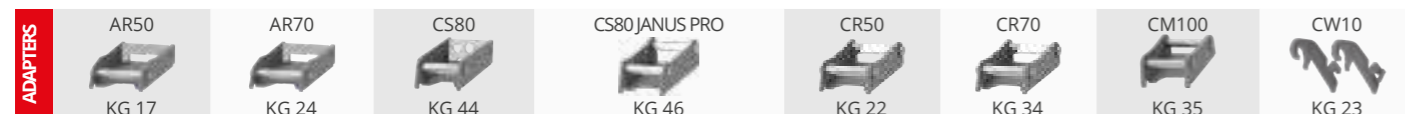

### OPTIONAL

- 4 LUNETTA
- 5 RASOIO POSTERIORE

L MM	PESO KG*	CAP. SAE L	ADAPTERS
1200	183	250	AF - AR - CS
			CR - CM
			CW - CS JANUS PRO
1400	211	298	AF - AR - CS
			CR - CM
			CW - CS JANUS PRO
1600	239	345	AF - AR - CS
			CR - CM
			CW - CS JANUS PRO
1800	266	392	AF - AR - CS
			CR - CM
			CW - CS JANUS PRO

## SPR55 PESO MACCHINA 7,5 - 10,0

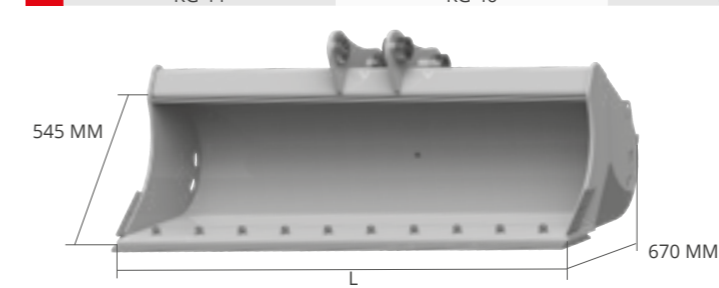

### OPTIONAL

- 4 LUNETTA
- 5 RASOIO POSTERIORE

L MM	PESO KG*	CAP. SAE L	ADAPTERS
1200	233	326	AF - CS
			CR - CM
			CW - CS JANUS PRO
1400	267	387	AF - CS
			CR - CM
			CW - CS JANUS PRO
1600	302	447	AF - CS
			CR - CM
			CW - CS JANUS PRO
1800	336	507	AF - CS
			CR - CM
			CW - CS JANUS PRO

## SPR60 MIDI PESO MACCHINA 10,0 - 12,0

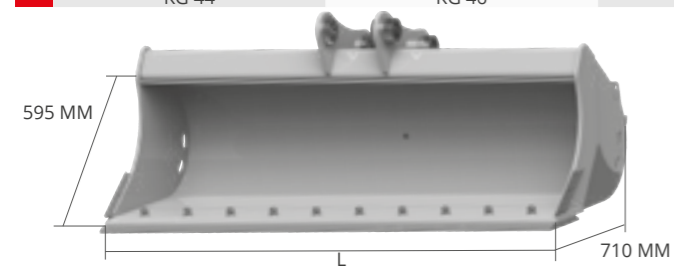

### OPTIONAL

- 4 LUNETTA
- 5 RASOIO POSTERIORE

L MM	PESO KG*	CAP. SAE L	ADAPTERS
1200	273	367	AF - CS
			CR - CM - CS JANUS PRO
			CW
1400	311	436	AF - CS
			CR - CM - CS JANUS PRO
			CW
1600	351	504	AF - CS
			CR - CM - CS JANUS PRO
			CW
1800	389	573	AF - CS
			CR - CM - CS JANUS PRO
			CW
2000	427	641	AF - CS
			CR - CM - CS JANUS PRO
			CW

\* peso vasca escluso di attacchi e denti

## SPR65 HD EXCAVATOR PESO MACCHINA 12,0 - 18,0

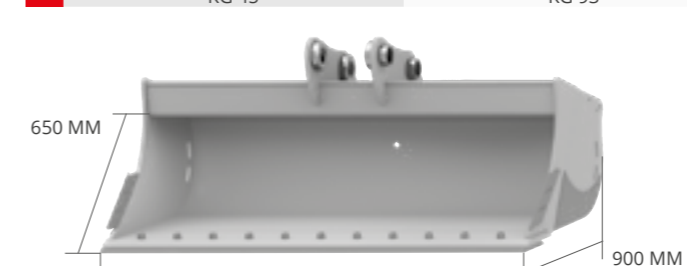
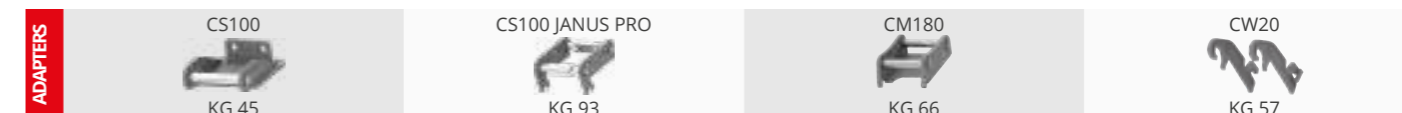

### OPTIONAL

- 4 LUNETTA
- 5 RASOIO POSTERIORE

L MM	PESO KG*	CAP. SAE L	ADAPTERS
1400	394	631	AF - CM
			CS - CW
			CS JANUS PRO
1500	420	665	AF - CM
			CS - CW
			CS JANUS PRO
1600	445	699	AF - CM
			CS - CW
			CS JANUS PRO
1800	496	767	AF - CM
			CS - CW
			CS JANUS PRO
2000	546	835	AF - CM
			CS - CW
			CS JANUS PRO

\* peso vasca escluso di attacchi e denti

# SPR70 HD PESO MACCHINA 18,0 - 22,0

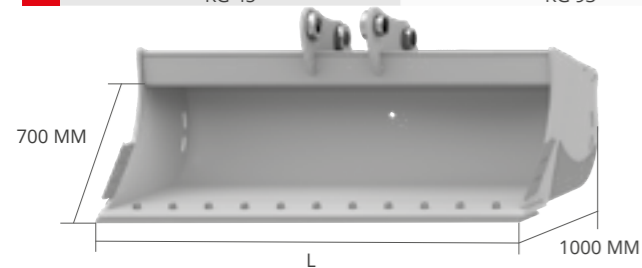
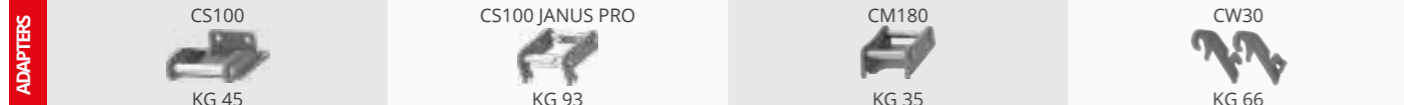

L MM	PESO KG*	CAP. SAE L	ADAPTERS
1500	512	780	AF - CM
			CS - CW
			CS JANUS PRO
1600	543	820	AF - CM
			CS - CW
			CS JANUS PRO
1800	604	900	AF - CM
			CS - CW
			CS JANUS PRO
2000	662	980	AF - CM
			CS - CW
			CS JANUS PRO
2200	719	1060	AF - CM
			CS - CW
			CS JANUS PRO

## OPTIONAL

- 4 LUNETTA
- 5 RASOIO POSTERIORE



\* peso vasca escluso di attacchi e denti