

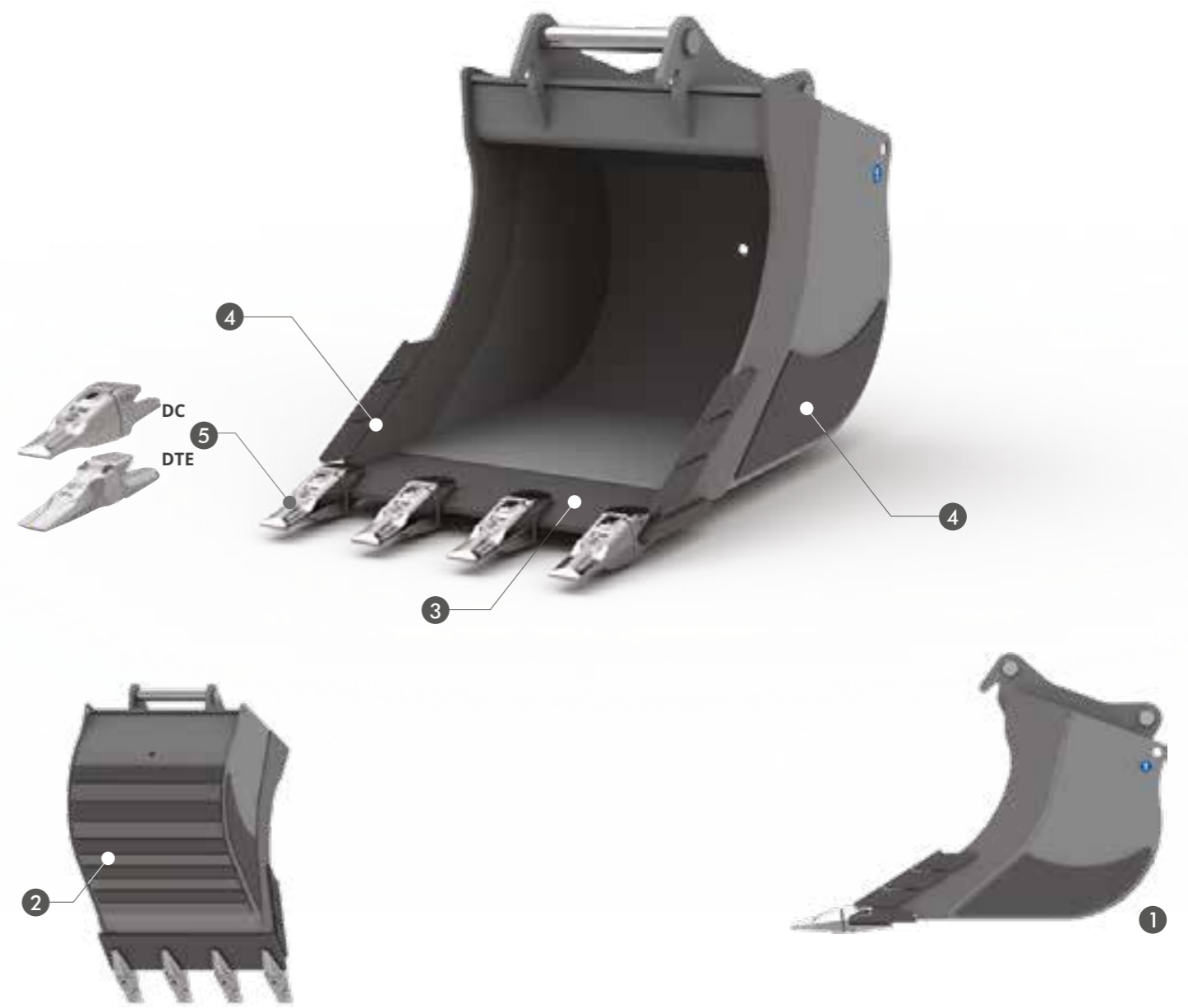

HB400



LA SUA FORMA ALLUNGATA EVITA CHE IL TERRENO ADERISCA ALLE PARETI LATERALI DELLA BENNA AGEVOLANDO LO SCARICO DI MATERIALI ARGILLOSI E BAGNATI. LA LAMA, I TAGLIENTI IN FUSIONE, I RINFORZI LATERALI E LE FASCE DI RINFORZO POSTERIORI SONO IN HB400.

SPECIFICHE TECNICHE STANDARD

- 1 PROFILO ALLUNGATO**
- 2 FASCE DI RINFORZO IN HB400**
LE FASCE DI RINFORZO ORIZZONTALI SALVAGUARDANO IL FONDO DALL'USURA AUMENTANDONE LA RESISTENZA.
- 3 LAMA IN HB400**
- 4 TAGLIENTI IN FUSIONE E RINFORZI LATERALI HB400**
REALIZZATI IN FUSIONE HB400, POSIZIONATI NELLE SUPERFICI DI MAGGIOR ATTRITO CONFERISCONO UN'ELEVATA RESISTENZA ALL'USURA.
- 5 DENTI DC DENTI DTE**

MOD.	MIDI							EXCAVATOR				
	SCS 35HD	SCS 40HD	SCS 48HD	SCS 60HD	SCS 67HD	SCS 71HD	SCS 75HD	SCS 80HD	SCS 85HD	SCS 92HD	SCS 100HD	SCS 110HD
TONS	0,8 - 1,5	1,5 - 2,0	2,0 - 3,0	3,0 - 4,0	4,0 - 6,0	6,0 - 7,5	7,5 - 9,0	9,0 - 12,0	12,0 - 14,0	12,0 - 14,0	14,0 - 18,0	18,0 - 22,0

SCS35 HD PESO MACCHINA 0,8 - 1,5

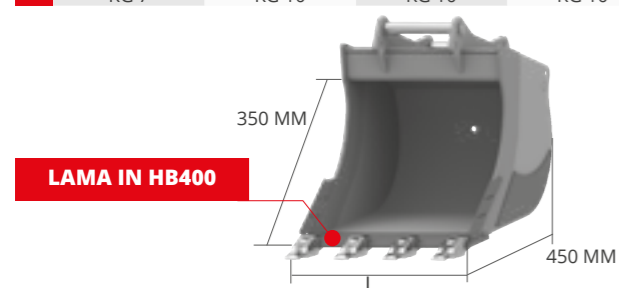

L MM	PESO KG*	CAP. SAE L	DENTI N°	ADAPTERS
250	20	22	3	AF - AR - CS
				CR - S - CM
				CW - CS JANUS PRO
300	24	26	3	AF - AR - CS
				CR - S - CM
				CW - CS JANUS PRO
400	30	40	3	AF - AR - CS
				CR - S - CM
				CW - CS JANUS PRO
500	35	50	4	AF - AR - CS
				CR - S - CM
				CW - CS JANUS PRO

SCS40 HD PESO MACCHINA 1,5 - 2,0

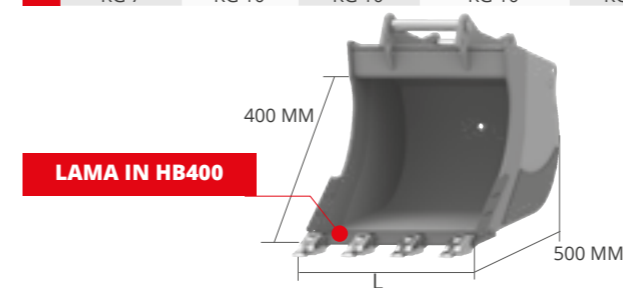

L MM	PESO KG*	CAP. SAE L	DENTI N°	ADAPTERS
300	26	35	3	AF - AR - CS
				CR - S - CM
				CW - CS JANUS PRO
400	34	45	3	AF - AR - CS
				CR - S - CM
				CW - CS JANUS PRO
500	42	60	4	AF - AR - CS
				CR - S - CM
				CW - CS JANUS PRO
600	49	85	4	AF - AR - CS
				CR - S - CM
				CW - CS JANUS PRO

SCS48 HD PESO MACCHINA 2,0 - 3,0

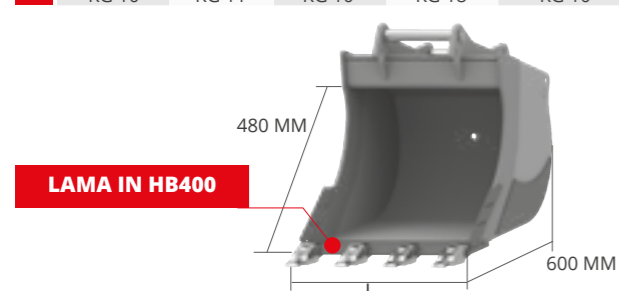

L MM	PESO KG*	CAP. SAE L	DENTI N°	ADAPTERS
300	38	48	3	AF - AR - CS
				CR - S - CM
				CW - CS JANUS PRO
400	48	68	3	AF - AR - CS
				CR - S - CM
				CW - CS JANUS PRO
500	61	85	4	AF - AR - CS
				CR - S - CM
				CW - CS JANUS PRO
600	72	110	4	AF - AR - CS
				CR - S - CM
				CW - CS JANUS PRO
800	98	160	5	AF - AR - CS
				CR - S - CM
				CW - CS JANUS PRO

SCS60 HD PESO MACCHINA 3,0 - 4,0

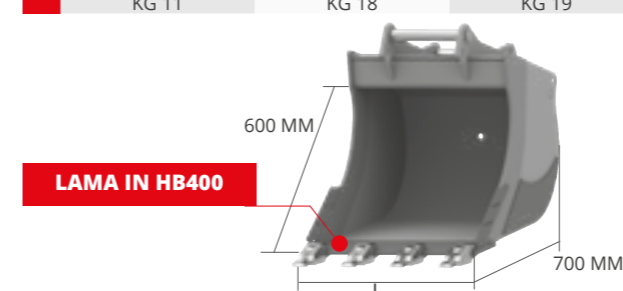

L MM	PESO KG*	CAP. SAE L	DENTI N°	ADAPTERS
300	52	78	3	AF - AR - CS
				CR - S - CM
				CW - CS JANUS PRO
400	63	105	3	AF - AR - CS
				CR - S - CM
				CW - CS JANUS PRO
500	76	140	4	AF - AR - CS
				CR - S - CM
				CW - CS JANUS PRO
600	91	165	4	AF - AR - CS
				CR - S - CM
				CW - CS JANUS PRO
800	112	225	5	AF - AR - CS
				CR - S - CM
				CW - CS JANUS PRO

* peso vasca escluso di attacchi e denti

* peso vasca escluso di attacchi e denti

SCS67 HD PESO MACCHINA 4,0 - 6,0

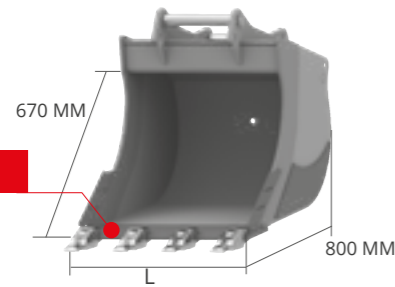

L MM	PESO KG*	CAP. SAE L	DENTI N°	ADAPTERS
300	75	90	3	AF - AR - CS CR - S - CM CW - CS JANUS PRO
400	85	130	3	AF - AR - CS CR - S - CM CW - CS JANUS PRO
500	105	170	4	AF - AR - CS CR - S - CM CW - CS JANUS PRO
600	122	200	4	AF - AR - CS CR - S - CM CW - CS JANUS PRO
800	160	280	5	AF - AR - CS CR - S - CM CW - CS JANUS PRO

SCS71 HD PESO MACCHINA 6,0 - 7,5

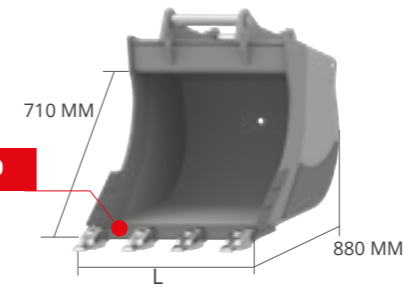

L MM	PESO KG*	CAP. SAE L	DENTI N°	ADAPTERS
400	108	150	3	AF - AR - CS CR - S - CM CW - CS JANUS PRO
500	130	190	4	AF - AR - CS CR - S - CM CW - CS JANUS PRO
600	154	230	4	AF - AR - CS CR - S - CM CW - CS JANUS PRO
700	176	260	5	AF - AR - CS CR - S - CM CW - CS JANUS PRO
800	197	315	5	AF - AR - CS CR - S - CM CW - CS JANUS PRO

SCS75 HD PESO MACCHINA 7,5 - 9,0

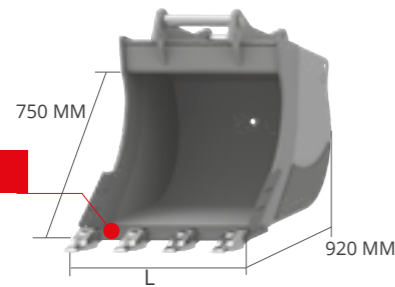

L MM	PESO KG*	CAP. SAE L	DENTI N°	ADAPTERS
400	123	165	3	AF - CS CR - S - CM CW - CS JANUS PRO
500	145	210	4	AF - CS CR - S - CM CW - CS JANUS PRO
600	170	260	4	AF - CS CR - S - CM CW - CS JANUS PRO
700	198	300	5	AF - CS CR - S - CM CW - CS JANUS PRO
800	220	350	5	AF - CS CR - S - CM CW - CS JANUS PRO
1000	263	450	5	AF - CS CR - S - CM CW - CS JANUS PRO

SCS80 HD PESO MACCHINA 9,0 - 12,0

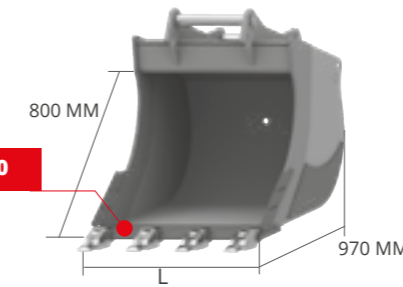
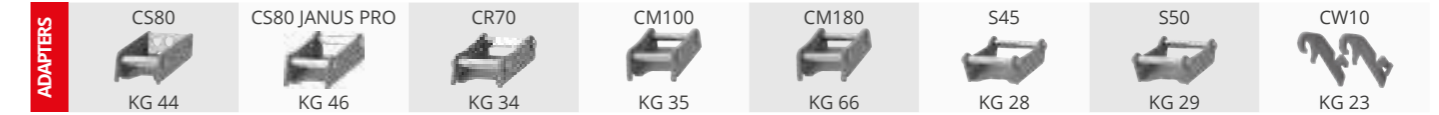

L MM	PESO KG*	CAP. SAE L	DENTI N°	ADAPTERS
400	133	190	3	AF - CS CR - S - CM CW - CS JANUS PRO
500	153	245	3	AF - CS CR - S - CM CW - CS JANUS PRO
600	178	300	4	AF - CS CR - S - CM CW - CS JANUS PRO
700	209	350	4	AF - CS CR - S - CM CW - CS JANUS PRO
800	234	400	5	AF - CS CR - S - CM CW - CS JANUS PRO
1000	283	500	5	AF - CS CR - S - CM CW - CS JANUS PRO

* peso vasca escluso di attacchi e denti

* peso vasca escluso di attacchi e denti

SCS85 HD **MIDI** PESO MACCHINA 12,0 - 14,0

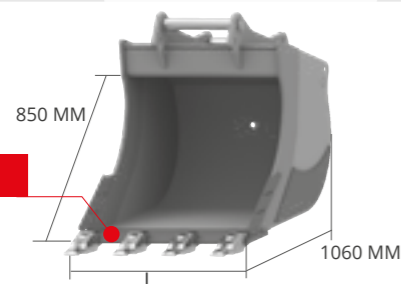

L MM	PESO KG*	CAP. SAE L	DENTI N°	ADAPTERS
500	197	265	3	AF - S - CM CS - CW CS JANUS PRO
600	225	330	4	AF - S - CM CS - CW CS JANUS PRO
700	256	400	4	AF - S - CM CS - CW CS JANUS PRO
800	284	450	5	AF - S - CM CS - CW CS JANUS PRO
900	312	500	5	AF - S - CM CS - CW CS JANUS PRO
1000	342	580	5	AF - S - CM CS - CW CS JANUS PRO
1200	383	740	6	AF - S - CM CS - CW CS JANUS PRO

SCS92 HD **EXCAVATOR** PESO MACCHINA 12,0 - 14,0

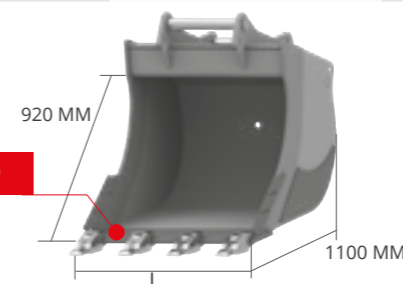

L MM	PESO KG*	CAP. SAE L	DENTI N°	ADAPTERS
600	261	380	4	AF - S - CM CS - CW CS JANUS PRO
700	287	450	4	AF - S - CM CS - CW CS JANUS PRO
800	320	560	5	AF - S - CM CS - CW CS JANUS PRO
900	352	620	5	AF - S - CM CS - CW CS JANUS PRO
1000	395	700	5	AF - S - CM CS - CW CS JANUS PRO
1200	454	900	6	AF - S - CM CS - CW CS JANUS PRO

SCS100 HD PESO MACCHINA 14,0 - 18,0

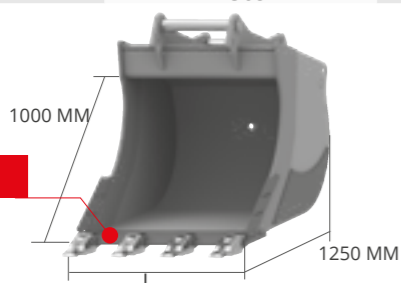

L MM	PESO KG*	CAP. SAE L	DENTI N°	ADAPTERS
600	353	450	3	AF - S - CM CS - CW CS JANUS PRO
700	397	535	4	AF - S - CM CS - CW CS JANUS PRO
800	441	620	4	AF - S - CM CS - CW CS JANUS PRO
900	485	710	4	AF - S - CM CS - CW CS JANUS PRO
1000	529	800	5	AF - S - CM CS - CW CS JANUS PRO
1200	617	980	5	AF - S - CM CS - CW CS JANUS PRO

* peso vasca escluso di attacchi e denti

SCS110 HD PESO MACCHINA 18,0 - 22,0

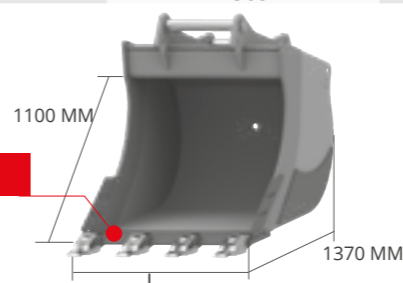

L MM	PESO KG*	CAP. SAE L	DENTI N°	ADAPTERS
600	457	480	3	AF - S - CM CS - CW CS JANUS PRO
800	559	690	4	AF - S - CM CS - CW CS JANUS PRO
1000	671	900	5	AF - S - CM CS - CW CS JANUS PRO
1200	773	1110	5	AF - S - CM CS - CW CS JANUS PRO
1300	824	1220	6	AF - S - CM CS - CW CS JANUS PRO
1400	875	1330	6	AF - S - CM CS - CW CS JANUS PRO

* peso vasca escluso di attacchi e denti