



HB400



LA SUA FORMA ALLUNGATA EVITA CHE IL TERRENO ADERISCA ALLE PARETI LATERALI DELLA BENNA AGEVOLANDO LO SCARICO DI MATERIALI ARGILLOSI E BAGNATI. LE FIANCATE INCAVATE FACILITANO LE OPERAZIONI DI ATTRAVERSAMENTO DI IMPIANTI IDRAULICI, GAS ETC. È RINFORZATA IN TUTTE LE ZONE SOGGETTE A MAGGIOR USURA: LA LAMA, I TAGLIENTI IN FUSIONE, I RINFORZI LATERALI E LE FASCE DI RINFORZO POSTERIORI SONO IN HB400.

MOD.	MIDI EXCAVATOR											
	BS 35HD	BS 40HD	BS 48HD	BS 60HD	BS 67HD	BS 71HD	BS 75HD	BS 80HD	BS 85HD	BS 92HD	BS 100HD	BS 110HD
TONS	0,8 - 1,5	1,5 - 2,0	2,0 - 3,0	3,0 - 4,0	4,0 - 6,0	6,0 - 7,5	7,5 - 9,0	9,0 - 12,0	12,0 - 14,0	12,0 - 14,0	14,0 - 18,0	18,0 - 22,0

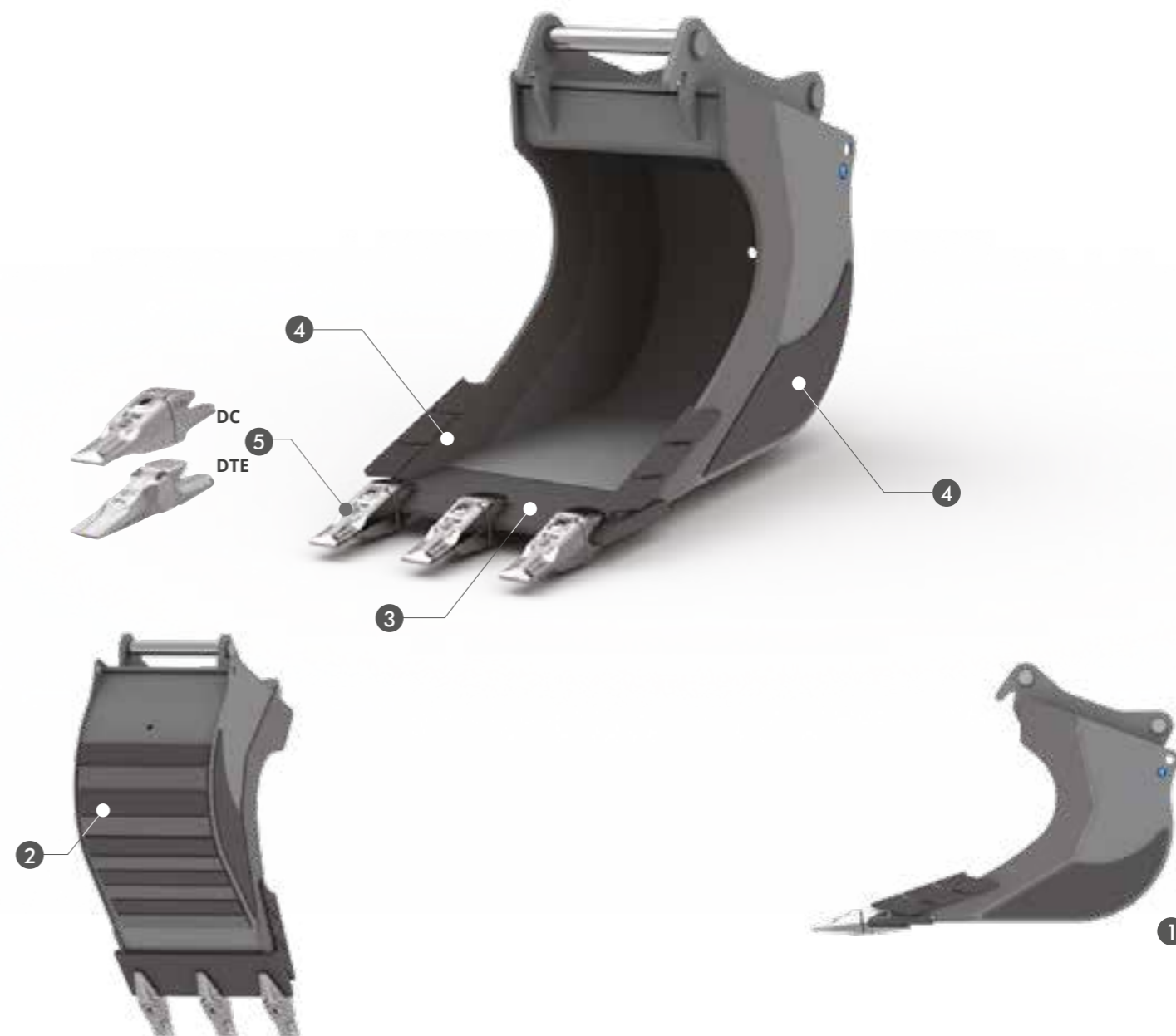

SPECIFICHE TECNICHE STANDARD

- 1 PROFILO ALLUNGATO**
- 2 FASCE DI RINFORZO IN HB400**
LE FASCE DI RINFORZO ORIZZONTALI SALVAGUARDANO IL FONDO DALL'USURA AUMENTANDONE LA RESISTENZA.
- 3 LAMA IN HB400**
- 4 TAGLIENTI IN FUSIONE E RINFORZI LATERALI HB400**
REALIZZATI IN FUSIONE HB400, POSIZIONATI NELLE SUPERFICI DI MAGGIOR ATTRITO CONFERISCONO UN'ELEVATA RESISTENZA ALL'USURA.
- 5 DENTI DC DENTI DTE**

BS35 HD PESO MACCHINA 0,8 - 1,5

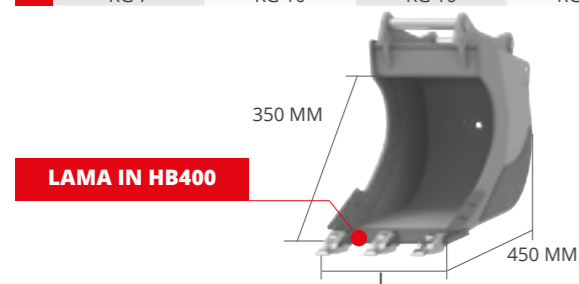

L MM	PESO KG*	CAP. SAE L	DENTI N°	ADAPTERS
250	22	24	3	AF - AR - CS
				CR - S - CM
				CW - CS JANUS PRO
300	24	29	3	AF - AR - CS
				CR - S - CM
				CW - CS JANUS PRO
350	27	35	3	AF - AR - CS
				CR - S - CM
				CW - CS JANUS PRO
400	31	41	3	AF - AR - CS
				CR - S - CM
				CW - CS JANUS PRO

BS40 HD PESO MACCHINA 1,5 - 2,0



L MM	PESO KG*	CAP. SAE L	DENTI N°	ADAPTERS
250	25	24	3	AF - AR - CS
				CR - S - CM
				CW - CS JANUS PRO
300	27	30	3	AF - AR - CS
				CR - S - CM
				CW - CS JANUS PRO
350	30	37	3	AF - AR - CS
				CR - S - CM
				CW - CS JANUS PRO
400	34	44	3	AF - AR - CS
				CR - S - CM
				CW - CS JANUS PRO

BS48 HD PESO MACCHINA 2,0 - 3,0



L MM	PESO KG*	CAP. SAE L	DENTI N°	ADAPTERS
250	37	36	3	AF - AR - CS
				CR - S - CM
				CW - CS JANUS PRO
300	42	45	3	AF - AR - CS
				CR - S - CM
				CW - CS JANUS PRO
350	47	54	3	AF - AR - CS
				CR - S - CM
				CW - CS JANUS PRO
400	53	63	3	AF - AR - CS
				CR - S - CM
				CW - CS JANUS PRO
500	64	83	4	AF - AR - CS
				CR - S - CM
				CW - CS JANUS PRO

BS60 HD PESO MACCHINA 3,0 - 4,0

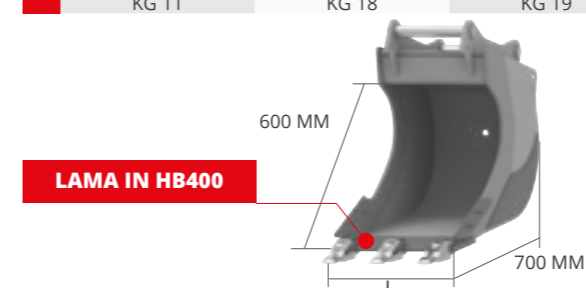

L MM	PESO KG*	CAP. SAE L	DENTI N°	ADAPTERS
250	48	54	3	AF - AR - CS
				CR - S - CM
				CW - CS JANUS PRO
300	53	66	3	AF - AR - CS
				CR - S - CM
				CW - CS JANUS PRO
350	60	79	3	AF - AR - CS
				CR - S - CM
				CW - CS JANUS PRO
400	66	93	3	AF - AR - CS
				CR - S - CM
				CW - CS JANUS PRO
500	78	121	4	AF - AR - CS
				CR - S - CM
				CW - CS JANUS PRO

* peso vasca escluso di attacchi e denti

* peso vasca escluso di attacchi e denti

BS67 HD PESO MACCHINA 4,0 - 6,0

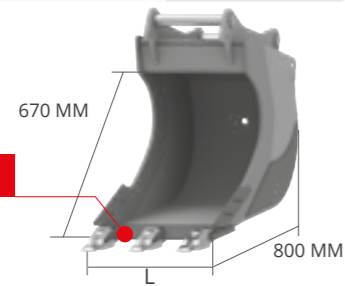

L MM	PESO KG*	CAP. SAE L	DENTI N°	ADAPTERS
300	70	78	3	AF - AR - CS
				CR - S - CM
				CW - CS JANUS PRO
350	80	95	3	AF - AR - CS
				CR - S - CM
				CW - CS JANUS PRO
400	90	111	3	AF - AR - CS
				CR - S - CM
				CW - CS JANUS PRO
500	109	146	4	AF - AR - CS
				CR - S - CM
				CW - CS JANUS PRO

BS71 HD PESO MACCHINA 6,0 - 7,5

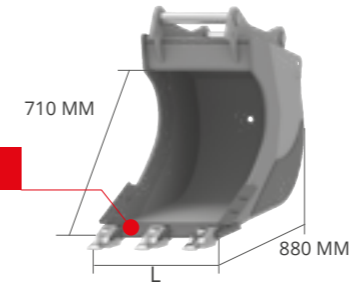

L MM	PESO KG*	CAP. SAE L	DENTI N°	ADAPTERS
350	101	112	3	AF - AR - CS
				CR - S - CM
				CW - CS JANUS PRO
400	111	132	3	AF - AR - CS
				CR - S - CM
				CW - CS JANUS PRO
500	133	172	3	AF - AR - CS
				CR - S - CM
				CW - CS JANUS PRO
600	152	215	4	AF - AR - CS
				CR - S - CM
				CW - CS JANUS PRO

BS75 HD PESO MACCHINA 7,5 - 9,0

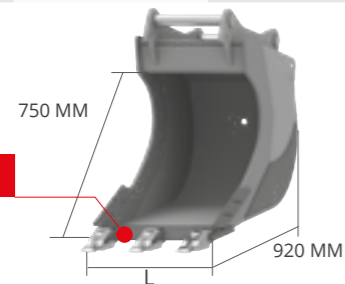

L MM	PESO KG*	CAP. SAE L	DENTI N°	ADAPTERS
350	106	117	3	AF - CS
				CR - S - CM
				CW - CS JANUS PRO
400	118	138	3	AF - CS
				CR - S - CM
				CW - CS JANUS PRO
500	138	181	3	AF - CS
				CR - S - CM
				CW - CS JANUS PRO
600	160	226	4	AF - CS
				CR - S - CM
				CW - CS JANUS PRO

BS80 HD PESO MACCHINA 9,0 - 12,0

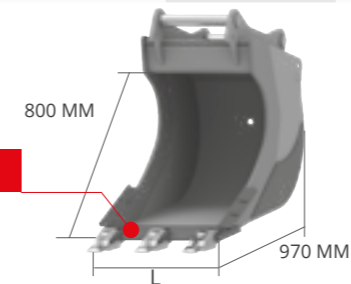

L MM	PESO KG*	CAP. SAE L	DENTI N°	ADAPTERS
400	130	161	3	AF - CS
				CR - S - CM
				CW - CS JANUS PRO
500	157	210	3	AF - CS
				CR - S - CM
				CW - CS JANUS PRO
600	186	261	3	AF - CS
				CR - S - CM
				CW - CS JANUS PRO

* peso vasca escluso di attacchi e denti

* peso vasca escluso di attacchi e denti

BS85 HD MIDI PESO MACCHINA 12,0 - 14,0



L MM	PESO KG*	CAP. SAE L	DENTI N°	ADAPTERS
400	164	184	3	AF - S - CM
				CS - CW
				CS JANUS PRO
500	192	242	3	AF - S - CM
				CS - CW
				CS JANUS PRO
600	220	301	4	AF - S - CM
				CS - CW
				CS JANUS PRO

BS92 HD EXCAVATOR PESO MACCHINA 12,0 - 14,0



L MM	PESO KG*	CAP. SAE L	DENTI N°	ADAPTERS
400	188	206	3	AF - S - CM
				CS - CW
				CS JANUS PRO
500	225	270	3	AF - S - CM
				CS - CW
				CS JANUS PRO
600	256	337	4	AF - S - CM
				CS - CW
				CS JANUS PRO

BS100 HD PESO MACCHINA 14,0 - 18,0



L MM	PESO KG*	CAP. SAE L	DENTI N°	ADAPTERS
400	259	245	3	AF - S - CM
				CS - CW
				CS JANUS PRO
500	301	320	3	AF - S - CM
				CS - CW
				CS JANUS PRO
600	343	398	3	AF - S - CM
				CS - CW
				CS JANUS PRO

BS110 HD PESO MACCHINA 18,0 - 22,0



L MM	PESO KG*	CAP. SAE L	DENTI N°	ADAPTERS
400	335	243	3	AF - S - CM
				CS - CW
				CS JANUS PRO
500	385	372	3	AF - S - CM
				CS - CW
				CS JANUS PRO
600	435	464	3	AF - S - CM
				CS - CW
				CS JANUS PRO

* peso vasca escluso di attacchi e denti

* peso vasca escluso di attacchi e denti